

**SINGER**  
**144W101,W201,W301**

Form 3197w  
(961)  
Printed in U.S.A.

**HISTORICAL COPY**  
**DO NOT REMOVE**

# LIST OF PARTS



## SINGER\*\*

MACHINE No. 144w305

---

THE SINGER MANUFACTURING COMPANY

\*\*A Trademark of THE SINGER MANUFACTURING COMPANY

From the library of: Diamond Needle Corp

## INSTRUCTIONS FOR ORDERING

In ordering from this list, use **ONLY** the **PART** number in the **FIRST** column.

The number stamped on a Sewing Machine Part is the number of the Single Part only, except when the part includes Set Screws, Clamping Screws, Studs and Rollers Spun on, Small Wires riveted, or Parts soldered together, etc., which it is necessary to furnish in combination.

Every combination of parts sent out has its specific number which, although not stamped on Parts (except in above case), must be used when ordering the combination.

Each number always indicates the **SAME PART** in whatever list it appears, or for whatever Machine.

The letters after some of the numbers indicate the style of finish only, as follows:

- A—Hardened, Polished, Nickel Plated and Buffed.
- AL—Heat Treated for Toughness.
- ALX—Heat Treated for Toughness and Black Oxide.
- B—Polished, Nickel Plated and Buffed.
- C—Hardened only.
- D—Polished only.
- E—Soft, Not polished.
- F—Hardened and Polished.
- J—Nickel Plated only.
- R—Merlized.
- X—Black Oxide, for Iron and Steel.
- XC—Hardened and Black Oxide, for Iron and Steel.
- Y—Black Nickel Plated only.
- Z—Chromium Plated.

These letters **MUST BE USED** when they appear in the list and **AFTER** the number, as in the list.

In this series

1 to 1500, 200001 to 201500 and 350001 to 351500 are Screw Numbers.

1501 to 1800, 201501 to 201800 and 351501 to 351800 are Nut Numbers.

1801 to 2000, 201801 to 202000 and 351801 to 352000 are Roller Numbers.

2001 to 50000 and 202001 to 350000 are Numbers of Machine Parts.

The figures in the second column refer only to the plate in which the illustration of the part is shown and are **NOT TO BE USED** in ordering.

Two or more numbers over a cut indicate that the difference between such parts is not visible in an illustration.

Parts marked with an asterisk (\*) are furnished only when repairs are made at the factory.

## NUMERICAL LIST OF PARTS

FOR

MACHINE NO. 144w305

No.	Plate	Name
176E	18522	Bobbin Winder Tripping Arm Clamping Screw, for 41899
214D	18526	Feed Reversing Lever Slide Block Stop Screw, for 240578
356C	16018	Feed Reversing Lever Set Screw, for 233565
356C	16018	Feed Reversing Treadle Set Screw, for 265135
356C	16149	Foot Lifter Treadle Set Screw, for 265385
356C	16149	Starting Treadle Set Screw, for 264531
356C	16149	Starting Treadle Shaft Lever Set Screw, for 265125
443C	18521	Feed Driving Eccentric Body Set Screw, for <del>240543</del> 240744
448ALX	18522	Bobbin Winder Friction Pulley Set Screw, for 43270
449ALX	18522	Bobbin Winder Frame Hinge Pin Set Screw, for 41894
742F	18527	Throat Plate Screw (2)
792D	18521	Bobbin Winder Tension Bracket Screw, for 265002
894D	18522	Bobbin Winder Base Screw, for 265130
1103C	18521	Feed Driving Eccentric Regulating Screw, for 240544
1139C	18526	Feed Reversing Lever Slide Block Hinge Screw
1517C	18526	Feed Reversing Lever Slide Block Spring Screw Nut
1560F	18529	Tension Thumb Nut, for 264677
2049	18526	Feed Reversing Lever Pin, for 240579
2102	18521	Bobbin Winder Tension Disc, for 225462
2102	18529	Tension Disc, for 264677
2269	18522	Bobbin Winder Stop Latch Pin, for 265026
4784	18522	Bobbin Winder Frame Oil Pad, for 265026
5604	18522	Bobbin Winder Friction Pulley Ring Rivet (brass) for 43270
8702	18524	Arm Position Pin (2)
13710	18521	Bobbin Winder Tension Spring, for 225462

NUMERICAL LIST OF PARTS

No.	Plate	Name
7739	13537	Thread Unwinder Thread Cone (wood) (Misc. Parts)
2572	18529	Tension Release Disc, for 264677
1400	13067	Machine Rest Pin (wood)
1441	18522	Bobbin Winder Frame Hinge Pin, for 265026
1894	18522	Bobbin Winder Base with 449ALX, for 265026
1896	18522	Bobbin Winder Frame, for 265026
1897	18522	Bobbin Winder Frame Spring, for 265026
1899	18522	Bobbin Winder Tripping Arm with 176E, for 265026
3270	18522	Bobbin Winder Friction Pulley with 43271, two 448ALX and ten 5604, for 265026
3271	18522	Bobbin Winder Friction Pulley Ring (leather) for 43270
0708E	18524	Arm Screw (4)
4897	18525	Bed Oil Cup
60913	13537	Thread Unwinder Spool Weight with 60914 (Misc. Parts)
60914	13537	Thread Unwinder Spool Weight Center Pin, for 60913
120342	13067	Oiler (copper plated) with 120343
120343	13067	Oiler Spout (3-1/2 in. long) for 120342
120203	13537	Thread Unwinder Spool Rest Cushion (felt) for 228776
00006E	18504	Hook Saddle Screw
00009E	18504	Hook Saddle Pinch Screw, for 223850
00019E	18526	Feed Reversing Crank Pinch Screw, for 223652
00019E	18526	Feed Reversing Lever Bracket Screw (2)
00029E	18526	Feed Driving Rock Shaft Crank Pinch Screw, for 240585
00029C	18525	Hook Driving Shaft Bushing (back) Set Screw
00029E	18521	Lifting Eccentric Connection Crank Pinch Screw, for 240171
00029C	18528	Needle Bar Rock Frame Hinge Stud Set Screw
00029E	18521	Needle Bar Rock Frame Rock Shaft Crank Pinch Screw, for 223692
00032E	18537	Presser Bar Lifting Bracket Pinch Screw, for 264625
00039C	18521	Machine Pulley Set Screw, for 265214
00049D	18523	Feed Driving Connection Pinch Screw, for 265132
00059C	16140	Thread Lubricating Cup Set Screw, for 236955

NUMERICAL LIST OF PARTS

No.	Plate	Name
200061ALX	18529	Thread Controller Spring Stud Set Screw, for 264674
200069C	18537	Presser Bar Spring Bracket Pinch Screw, for 265382
200071E	18521	Arm Shaft Bushing (back) Screw (3)
200074F	18537	Lifting Presser Foot Screw, for 264690
200077D	16140	Arm Side Cover (back) Screw (3)
200086ALX	18528	Needle Bar Connecting Stud Pinch Screw, for 265054
200086ALX	18537	Presser Bar Position Guide Lever Pinch Screw, for 264627
200086ALX	18528	Vibrating Presser Foot Pinch Screw, for 264613
200098F	18528	Needle Bar Rock Frame Position Bracket Screw
200112F	18528	Needle Set Screw, for 265079
200118D	18504	Bobbin Case Opener Screw, for 265369
200132E	18529	Thread Controller Spring Stop Screw, for 264677
200159F	18529	Tension Bracket Screw (2)
200164X	18525	Arm Shaft Connection Belt Timing Plate Screw (2)
200166X	16140	Arm Cover Screw (2)
200173D	18526	Feed Lifting Cam Oiling Felt Screw, for 264637
200194E	18525	Bed Block (for Hook Saddle) Screw (2)
200224X	18524	Presser Bar Spring Support Screw
200268F	18524	Foot Lifter Lifting Lever Spring Screw
200278X	18521	Arm Cap Screw
200309E	18529	Tension Release Lever Screw, for 264677
200327C	18523	Arm Shaft Connection Belt Pulley Set Screw, for 265109
200335C	18528	Needle Bar Crank Set Screw, for 265111
200338C	18521	Arm Shaft Bushing (center) Set Screw
200338C	18521	Arm Shaft Bushing (front) Set Screw
200342C	18523	Arm Shaft Connection Belt Pulley Position Screw, for 265109
200352AL	18537	Presser Bar Bushing Set Screw (2)
200352AL	18537	Presser Bar Position Guide Set Screw
200354C	18525	Hook Driving Shaft Lock Ratchet Position Screw, for 265043
200362C	18525	Hook Driving Shaft Lock Ratchet Set Screw, for 265043
200363AL	18523	Arm Shaft Connection Belt Pulley Position Screw Check Screw
200363AL	18526	Feed Bar Crank Set Screw, for 264634
200363AL	18524	Foot Lifter Lifting Lever Hinge Stud Set Screw

## NUMERICAL LIST OF PARTS

No.	Plate	Name
200363AL	18525	Hook Driving Shaft Bushing (front) Set Screw
200364C	18504	Hook Bushing (lower) Set Screw, for 265098
200364C	18525	Safety Clutch Locking Lever Hinge Stud Set Screw, for 240538
200364C	18525	Safety Clutch Locking Lever Spring Stud Set Screw, for 240538
200374AL	18528	Needle Bar Connecting Link Stud Set Screw, for 265111
200382ALX	16140	Arm Cross Shaft Gear Set Screw, for 265075
200382ALX	18504	Hook Driving Pinion Set Screw, for 240167
200382ALX	18521	Lifting Eccentric Set Screw, for 264609
200383C	18525	Arm Shaft Connection Belt Timing Collar Set Screw, for 264503
200383C	18525	Hook Driving Shaft Bushing (front) Set Screw Check Screw
200383C	18528	Needle Bar Crank Set Screw Check Screw
200386C	18526	Feed Driving Rock Shaft Stop Collar Set Screw, for 240586
200387C	18504	Bobbin Case Opener Lever Hinge Stud Set Screw Check Screw, for 265369
200387C	18521	Needle Bar Rock Frame Slide Block Screw Stud Set Screw, for 265021
200388C	18528	Needle Bar Connecting Link Stud Set Screw, for 265111
200396C	18526	Feed Bar Crank Position Screw, for 264634
200398C	18525	Arm Shaft Connection Belt Timing Collar Position Screw, for 264503
200398C	18521	Lifting Eccentric Position Screw, for 264609
200403C	18504	Bobbin Case Opener Lever Hinge Stud Set Screw, for 265369
200425C	18528	Needle Bar Crank Position Screw, for 265111
200446C	18504	Hook Bushing (upper) Position Screw, for 265098
200502X	18521	Arm Shaft Bushing (front) Oil Packing Thumb Screw
200533X	18524	Face Plate Thumb Screw
200570E	18524	Bed Hinge Connection Screw (4)
200577AL	16140	Hand Wheel Engaging Plate Screw, for 265072
200583X	18503	Hook Needle Guard Screw for 265360
200583X	18529	Thread Guide Screw, for 264677
200597F	18503	Bobbin Case Tension Spring Screw, for 265090

## NUMERICAL LIST OF PARTS

No.	Plate	Name
200833C	18523	Needle Bar Rock Frame Rock Shaft Crank Connection Hinge Screw
200904XC	18529	Thread Guide Screw (2)
200975F	18537	Presser Bar Lifting Bracket Guide Screw
200983F	18503	Bobbin Case Tension Spring Regulating Screw, for 265090
200996C	18521	Lifting Bell Crank Cap Screw
201007C	18528	Needle Bar Crank Position Screw Check Screw
201052ALX	18526	Feed Reversing Lever Shaft Collar Set Screw, for 224335
201052ALX	18524	Foot Lifter Lifting Lever Latch Collar Set Screw, for 227224
201052ALX	18524	Foot Lifter Lifting Lever Latch Handle Set Screw, for 265014
201052ALX	18524	Foot Lifter Lifting Lever Latch Spring Adjusting Collar Set Screw, for 265027
201052ALX	18529	Thread Controller Stud Set Screw, for 264681
201054F	16140	Hand Wheel Screw, for 265072
201129D	18521	Feed Driving Eccentric Set Screw, for 240544
201141C	18521	Needle Bar Rock Frame Slide Block Screw Stud, for 210920
201171C	18526	Feed Reversing Link Hinge Screw
201220ALX	16140	Arm Cross Shaft Gear Position Screw, for 265075
201220ALX	18525	Feed Lifting Cam Set Screw, for 224154
201220ALX	18504	Hook Driving Pinion Position Screw, for 240167
201253F	18503	Hook Gib Section Screw, for 265360
201254C	18525	Hook Driving Gear Position Screw, for 265053
201254C	18525	Safety Clutch Hook Driving Shaft Position Collar Set Screw, for 265032
201254C	13537	Thread Unwinder Spool Rest Set Screw, for 228766
201334X	18528	Needle Bar Thread Guide Screw, for 265079
201349C	18504	Bobbin Case Opener Lever Driving Screw Stud, for 265087
201421C	18525	Hook Driving Gear Set Screw, for 265053
201491E	18527	Feed Dog Screw (2)
201499X	18521	Bobbin Winder Tension Stud, for 225461
201517E	18523	Feed Driving Connection Hinge Screw Nut

## NUMERICAL LIST OF PARTS

No.	Plate	Name
201517D	18526	Feed Reversing Crank Screw Stud Nut
201517C	18526	Feed Reversing Link Hinge Screw Nut
201518E	18526	Feed Bar Hinge Screw Nut
201522E	18523	Needle Bar Rock Frame Rock Shaft Crank Connection Hinge Screw Nut
201524E	18521	Lifting Bell Crank Link Screw Stud Nut, for 264615
201535E	18529	Thread Controller Thread Guide Nut, for 264677
201542C	18504	Bobbin Case Opener Lever Driving Screw Stud Nut, for 265087
201572X	18521	Bobbin Winder Tension Stud Thumb Nut, for 225462
201572X	16140	Thread Lubricating Cup Oil Pad (upper) Tension Spring Thumb Nut, for 236963
201723C	18526	Feed Reversing Lever Slide Block Hinge Screw Nut
*202056	-----	Bobbin Case Latch Pin, for 265090
202079	18529	Thread Controller Disc Washer, for 264677
202135	18524	Face Plate Position Pin
202244	18521	Arm Shaft Bushing (back) Oil Packing (wick) for 264641
202244	18521	Arm Shaft Bushing (front) Oil Packing (wick) for 207080
202244	18525	Hook Driving Shaft Bushing (back) Oil Packing (wick) for 224111
202248	18521	Arm Cap Screw Washer
202253	18523	Arm Shaft Connection Belt Pulley Spring Flange, for 265109
202253	18525	Safety Clutch Pulley Spring Flange, for 240538
202260	16140	Arm Cross Shaft Bushing Oil Packing (wick) for 265074
202260	18521	Arm Shaft Bushing (center) Oil Packing (wick) for 265048
202277	18504	Bobbin Case Opener Lever Hinge Stud Oil Packing (wick) for 265088
202277	18523	Feed Driving Connection Hinge Screw Oil Packing (wick)
202277	18526	Feed Reversing Link Hinge Screw Oil Packing (wick)
202277	18528	Needle Bar Rock Frame Hinge Stud Oil Packing (wick) for 210910
202277	18523	Needle Bar Rock Frame Rock Shaft Crank Connection Oil Packing (wick) for 264638
202277	18528	Take-up Lever Driving Stud Oil Packing (wick) for 264629

## NUMERICAL LIST OF PARTS

No.	Plate	Name
202277	18528	Vibrating Presser Bar Oil Packing (wick)
202330	18523	Feed Driving Connection Oil Packing (wick) for 265132
202330	18528	Needle Bar Connecting Stud Oil Packing (wick) for 265054
202400	18528	Take-up Lever Hinge Stud with 202423
202412	18529	Thread Guide
202423	18528	Take-up Lever Hinge Stud Oil Packing (wick) for 202400
202666	18528	Needle Bar Rock Frame Position Bracket
202668	18521	Needle Bar Rock Frame Slide Block, for 210920
202784	16018	Feed Reversing Lever Chain Hook, for 232365
202784	16149	Foot Lifter Lever Chain Hook, for 232365
203101	18504	Bobbin Case Opener Lever Driving Screw Stud Oil Packing (wick) for 265087
203172	18528	Needle Bar Crank Friction Washer
207072	18537	Presser Bar Bushing (upper)
207080	18521	Arm Shaft Bushing (front) with 202244
208639	18526	Feed Reversing Lever Slide Block Spring Holding Eyelet, for 265134
210910	18528	Needle Bar Rock Frame Hinge Stud with 202277
210920	18521	Needle Bar Rock Frame Slide Block 202668 with 201141C, for 265021
222598	18528	Needle Bar Connecting Link Stud Oil Packing (wick) for 264667
222712	16140	Thread Lubricating Cup Oil Pad (upper) Tension Spring, for 236963
223438	18529	Tension Spring, for 264677
223652	18526	Feed Reversing Crank with 200019E
223655	18526	Feed Lifting Cam Oiling Felt, for 264637
223681	18525	Hook Saddle Bearing
223692	18521	Needle Bar Rock Frame Rock Shaft Crank with 200029E
223811	18524	Bed Slide (back) Stop
223812	18524	Bed Slide (back) Stop Spring
223850	18504	Hook Saddle with 200009E, for 265098
224019	18504	Hook Bushing (lower) (bronze) for 265098
224022	18504	Hook Driving Pinion Thrust Washer, for 265369
224111	18525	Hook Driving Shaft Bushing (back) with 202244
224154	18525	Feed Lifting Cam with 201220ALX

No.	Plate	Name
224335	18526	Feed Reversing Lever Shaft Collar with two 201052ALX
225004	18524	Presser Bar Spring Support Screw Washer
225390	13537	Thread Unwinder Thread Cone Holder (Misc. Parts)
225461	18521	Bobbin Winder Tension Bracket with 201499X, for 225462
225462	18521	Bobbin Winder Tension Bracket complete, Nos. 13710, 201572X, 225461 and two 2102, for 265002
225498	13067	Screw Driver (7-1/4 in. long)
225554	13067	Wrench (steel)
225585	18504	Hook Saddle Screw Washer
225837	18526	Feed Lifting Cam Fork Screw Washer
227116	18524	Foot Lifter Lifting Lever Latch Spring Adjusting Collar, for 265027
227224	18524	Foot Lifter Lifting Lever Latch Collar with 201052ALX
228026	18521	Bobbin Winder Tension Bracket Screw Washer, for 265002
228476	13067	Screw Driver (Bobbin Case)
228764	13537	Thread Unwinder Spool Pin, for 228776
228766	13537	Thread Unwinder Spool Rest (for two spools) (flat) with 201254C, for 228776
228767	13537	Thread Unwinder Spool Rest Rod, for 228776
228768	13537	Thread Unwinder Spool Stand, for 228776
228769	13537	Thread Unwinder Thread Guide, for 228776
228770	13537	Thread Unwinder Thread Guide Holder (for one or two guides) for 228776
228774	13537	Thread Unwinder Thread Guide Rod, for 228776
228776	13537	Thread Unwinder (for two spools) complete, Nos. 228766, 228767, 228768, 228770, 228774, two each 150203, 228764, 228769 and three wood screws 7/8 in., No. 12
232244	18526	Feed Reversing Lever Bracket Position Pin (2)
232365	16018	Feed Reversing Lever Chain, 41-1/2 in. long, with two 202784, for 265136
232365	16149	Foot Lifter Lever Chain, 41-1/2 in. long, with two 202784, for 265084
232719	16140	Hand Wheel Engaging Collar Pin, for 265072
233536	18526	Feed Reversing Link
233542	18526	Feed Reversing Lever Slide Block

No.	Plate	Name
233546	18526	Feed Reversing Lever Slide Block Spring and Treadle Connecting Link
233565	16018	Feed Reversing Lever with two 356C, for 265136
236955	16140	Thread Lubricating Cup with 200059C and 350575C, for 236963
236957	16140	Thread Lubricating Cup Oil Pad (felt) for 236961 and 236963
236959	16140	Thread Lubricating Cup Oil Pad (upper) Reinforcing Plate, for 236961
236961	16140	Thread Lubricating Cup Oil Pad (upper) complete, Nos. 236957 and 236959, for 236963
236962	16140	Thread Lubricating Cup Thread Guide, for 236963
236963	16140	Thread Lubricating Cup complete, Nos. 201572X, 222712, 236955, 236961, 236962 and three 236957
*237195	18521	Feed Driving Eccentric, for 240544
237529	18525	Hook Driving Shaft Bushing (front)
238089	18529	Tension Release Lever Guide Pin, for 264674
240167	18504	Hook Driving Pinion (spiral) with 200382ALX and 201220ALX, for 265369
240171	18521	Lifting Eccentric Connection Crank with 200029E and 248821
240172	18524	Presser Bar Spring (flat)
240174	18521	Lifting Rock Shaft Bushing, for 265126
240519	18525	Safety Clutch Locking Lever, for 240539
240520	18525	Safety Clutch Locking Lever Connecting Link, for 240539
240522	18525	Safety Clutch Throw-in Latch Pin, for 240539
240536	18525	Safety Clutch Locking Lever Hinge Stud, for 240539
240538	18525	Safety Clutch Pulley with 202253 and two 200364C, for 240539
240539	18525	Safety Clutch complete, Nos. 240519, 240520, 240522, 240536, 240538, 240641, 265032, 265051, 265057, and 265102
*240543	18521	Feed Driving Eccentric Body with 443C and 350107C, for 240544
240544	18521	Feed Driving Eccentric complete, Nos. 1103C, 201129D, 237195 and 240543
240578	18526	Feed Reversing Lever with two 214D, for 240579



No.	Plate	Name
240579	18526	Feed Reversing Lever 240578 with 2049 and 240581
240581	18526	Feed Reversing Lever Shaft, for 240579
240585	18526	Feed Driving Rock Shaft Crank with 200029E
240586	18526	Feed Driving Rock Shaft Stop Collar with two 200386C
240641	18525	Safety Clutch Locking Lever Spring Stud (eccentric) for 240539
241535	18537	Presser Bar Bushing (lower)
248251	18504	Bobbin Case Opener Lever Link, for 265369
248423	18525	Hook Driving Shaft Lock Stud Cotter Pin, for 265046
248425	18525	Hook Driving Shaft Lock Stud Spring, for 265046
248821	18521	Lifting Eccentric Connection Crank Oil Packing (wick) for 240171
260628	18522	Bobbin Winder Bracket Screw Washer, for 265130
264503	18525	Arm Shaft Connection Belt Timing Collar with 200383C and 200398C
264518	18524	Foot Lifter Lifting Lever Pin, for 265011
264531	16149	Starting Treadle with two 356C, for 265084
264539	16018	Feed Reversing Treadle Stand with two wood screws 1 in., No. 12, for 265136
264539	16149	Starting Treadle Stand with two wood screws 1 in., No. 12, for 265084
264603	18524	Bed Slide (back)
264604	18524	Bed Slide (front)
264607	18521	Lifting Bell Crank
264608	18521	Lifting Bell Crank Link
264609	18521	Lifting Eccentric with 200382ALX and 200398C
264610	18521	Lifting Eccentric Connection
264611	18537	Lifting Presser Foot, for 264613
264613	18528	Vibrating Presser Foot, 23 needle hole, with 200086ALX, for 264611, for use with thread larger than No. 12
264615	18521	Lifting Rock Shaft with 201524E and 350172C
264617	18528	Needle Bar Connecting Link
264620	18528	Needle Bar Rock Frame
264625	18537	Presser Bar Lifting Bracket with 200032E

No.	Plate	Name
264626	18537	Presser Bar Position Guide
264627	18537	Presser Bar Position Guide Lever with 200086ALX
264629	18528	Take-up Lever Driving Stud with 202277
264630	18528	Vibrating Presser Bar
264631	18521	Vibrating Presser Bar Connecting Link
264633	18526	Feed Bar
264634	18526	Feed Bar Crank with 200363AL and 200396C
264637	18526	Feed Lifting Cam Fork with 200173D and 223655
264638	18523	Needle Bar Rock Frame Rock Shaft Crank Connection with 202277
264641	18521	Arm Shaft Bushing (back) with 202244
264644	18525	Bed Block (for Hook Saddle)
264645	18503	Bobbin
264648	18503	Bobbin Case Latch Plunger, for 265090
264649	18503	Bobbin Case Latch Spring, for 265090
264650	18503	Bobbin Case Oiling Felt, for 265090
264667	18528	Needle Bar Connecting Link Stud with 222598, for 265111
264674	18529	Tension Bracket with 200061ALX, 238089 and 350392C, for 264677
264675	18529	Tension Release Lever, for 264677
264676	18537	Tension Release Lever Rod
264677	18529	Tension Bracket complete, Nos. 1560F, 32572, 200132E, 200309E, 201535E, 202079, 223438, 264674, 264675, 264678, 264681 to 264684, 264695, 265077, 265141, 265331, 265334, two 2102 and four 200583X
264678	18529	Thread Controller Disc, for 264677
264681	18529	Thread Controller Spring Stud with 201052ALX, for 264677
264682	18529	Thread Controller Stud, for 264677
264683	18529	Thread Controller Thread Guide, for 264677
264684	18529	Thread Guide (upper) for 264677
264690	18537	Presser Bar with 200074F
264693	18527	Throat Plate, for 265100
264695	18529	Tension Release Plunger, for 264677
265001	18521	Arm Cap, for 265002
265002	18521	Arm Cap and Tension Bracket complete, Nos. 792D, 225462, 228026 and 265001
265003	16140	Arm Cover
265005	16140	Arm Side Cover (back)
265006	16140	Arm Side Cover (back) Gasket
265009	18526	Feed Driving Rock Shaft



No.	Plate	Name
265011	18524	Foot Lifter Lifting Lever with 264518
265012	18524	Foot Lifter Lifting Lever Hinge Stud
265013	18524	Foot Lifter Lifting Lever Latch
265014	18524	Foot Lifter Lifting Lever Latch Handle with four 201052ALX
265015	18524	Foot Lifter Lifting Lever Latch Spring
(265020)	18525	Hook Driving Shaft
265021	18521	Needle Bar Rock Frame Rock Shaft with 200387C and 210920
265023	18522	Bobbin Winder Spindle, for 265026
265024	18522	Bobbin Winder Stop Latch, for 265026
265025	18522	Bobbin Winder Stop Latch Hinge Pin, for 265026
265026	18522	Bobbin Winder complete, Nos. 2269, 41441, 41894, 41896, 41897, 41899, 43270, 265023 to 265025 and two 4784, for 265130
265027	18524	Foot Lifter Lifting Lever Latch Spring Adjusting Collar 227116 with 201052ALX
265032	18525	Safety Clutch Hook Driving Shaft Position Collar with two 201254C, for 240539
265043	18525	Hook Driving Shaft Lock Ratchet with 200354C and 200362C
265044	18525	Hook Driving Shaft Lock Stud, for 265046
265045	18525	Hook Driving Shaft Lock Stud Socket, for 265046
265046	18525	Hook Driving Shaft Lock Stud complete, Nos. 248423, 248425, 265044 and 265045
265048	18521	Arm Shaft Bushing (center) with 202260
265051	18525	Safety Clutch Throw-in Latch Spring, for 240539
265053	18525	Hook Driving Gear (spiral) with 201254C and 201421C
265054	18528	Needle Bar Connecting Stud with 202330 and two 200086ALX
265057	18525	Safety Clutch Throw-in Latch, for 240539
265060	18524	Presser Bar Spring (auxiliary)
265066	18504	Bobbin Case Opener, for 265369
265067	16140	Hand Wheel, for 265072
265068	16140	Hand Wheel Disengaging Spring, for 265072
265069	16140	Hand Wheel Disengaging Spring Plunger, for 265072
265070	16140	Hand Wheel Engaging Collar, for 265072

No.	Plate	Name
265071	16140	Hand Wheel Engaging Plate, for 265072
265072	16140	Hand Wheel complete, Nos. 201054F, 232719, 265067, 265070, 265071, 265073 to 265075, 350419X, three each 265068, 265069 and four 200577AL
265073	16140	Arm Cross Shaft, for 265072
265074	16140	Arm Cross Shaft Bushing with 202260, for 265072
265075	16140	Arm Cross Shaft Gear with 200382ALX and 201220ALX, for 265072
265076	-----	Thread Controller Spring (light) (Furnished in place of 265331 as ordered)
265077	18529	Thread Controller Spring Stop, for 264677
265078	18524	Foot Lifter Lifting Lever Spring
265079	18528	Needle Bar with 200112F, 201334X and 265120
265080	16149	Foot Lifter Lever, for 265084
265081	16018	Feed Reversing Lever Shaft, for 265136
265081	16149	Starting Treadle Shaft, for 265084
265084	16149	Foot Lifter and Starting Treadle complete, for use when operator sits in front of needle, Nos. 232365, 264531, 265080, 265081, 265106, 265125, 265385 and two 264539
*265086	-----	Bobbin Case, for 265090
265087	18504	Bobbin Case Opener Lever with 201349C, 201542C and 203101, for 265369
265088	18504	Bobbin Case Opener Lever Hinge Stud with 202277, for 265369
265090	18503	Bobbin Case complete, Nos. 200597F, 200983F, 202056, 264648 to 265650, 265086, 265105 and 265115, for 265361
265094	18504	Hook Bushing (upper) (bronze) for 265098
265095	18503	Hook Gib Section (long) for 265360
265096	18503	Hook Gib Section (short) for 265360
265097	18503	Hook Needle Guard, for 265360
265098	18504	Hook Saddle 223850 with 200364C, 200446C, 224019 and 265094, for 265369
265100	18527	Feed Dog, 30 elongated needle hole, for needle size 27, for use with thread larger than No. 12, for 264693

No.	Plate	Name
265102	18525	Safety Clutch Locking Lever Spring, for 240539
265105	18503	Bobbin Case Tension Spring, for 265090
265106	16149	Starting Treadle Support with two wood screws 1 in., No. 12, for 265084
265109	18523	Arm Shaft Connection Belt Pulley with 200327C, 200342C and two 202253
265111	18528	Needle Bar Crank with 200335C, 200374AL, 200388C, 200425C and 264667
265115	18503	Bobbin Case Latch, for 265090
265120	18528	Needle Bar Thread Guide, for 265079
265121	18523	Arm Shaft Connection Belt (reinforced neoprene)
265125	16149	Starting Treadle Shaft Lever with two 356C, for 265084
*265126	-----	Arm with two each 240174, 350596X and 350597X
265127	18525	Arm Shaft Connection Belt Timing Plate
*265128	-----	Bed
265129	18522	Bobbin Winder Bracket, for 265130
265130	18522	Bobbin Winder and Bracket complete, Nos. 260628, 265026, 265129, 350030E and three 894D
265131	16018	Drip Pan with eight 3/4 in. No. 13 plain barbed roofing nails
265132	18523	Feed Driving Connection with 200049D and 202330
265133	18526	Feed Reversing Lever Bracket
265134	18526	Feed Reversing Lever Slide Block Spring with two 208639
265135	16018	Feed Reversing Treadle with two 356C, for 265136
265136	16018	Feed Reversing Treadle complete, Nos. 232365, 233565, 265081, 265135 and two 264539
265141	18529	Thread Guard, for 264677
265213	18521	Arm Shaft
265214	18521	Machine Pulley (belt groove 6-3/4 in. diam.) with two 200039C
265215	18521	Hand Wheel Driving Gear with two 350474C
265307	18524	Bed Hinge Connection (2)
265308	18528	Take-up Lever
265318	18524	Face Plate
265331	18529	Thread Controller Spring, for 264677 (Furnished with Machine)
265334	18529	Thread Guide (lower) for 264677

No.	Plate	Name
265336	18529	Thread Guide (lower)
265353	16140	Arm Side Cover (front)
*265359	18503	Hook, for 265360
265360	18503	Hook 265359 with 265095 to 265097, two 200583X and four 201253F, for 265361
265361	18503	Hook and Bobbin Case complete, Nos. 265090 and 265360, for 265369
265369	18504	Hook Saddle complete, Nos. 200118D, 200387C, 200403C, 224022, 240167, 248251, 265066, 265087, 265088, 265098 and 265361
265382	18537	Presser Bar Spring Bracket with 200069C
265385	16149	Foot Lifter Treadle with two 356C, for 265084
350030E	18522	Bobbin Winder Bracket Screw, for 265130
350107C	18521	Feed Driving Eccentric Body Position Screw, for 240543
350132X	16140	Arm Side Cover (front) Screw (5)
350172C	18521	Lifting Bell Crank Link Screw Stud, for 264615
350381C	18524	Presser Bar Spring Regulating Screw
350392C	18529	Tension Stud, for 264674
350393C	18526	Feed Bar Hinge Screw (driving)
350419X	16140	Arm Cross Shaft Gear Adjusting Screw, for 265072
350419X	18521	Machine Pulley Adjusting Screw
350451C	18525	Hook Saddle Bearing Set Screw
350452C	16140	Arm Cross Shaft Bushing Set Screw
350452E	18528	Take-up Lever Hinge Stud Set Screw
350474C	18521	Hand Wheel Driving Gear Set Screw, for 265215
350495E	18526	Feed Lifting Cam Fork Screw
350575C	16140	Thread Lubricating Cup Oil Pad (upper) Tension Screw Stud, for 236955
350582C	18526	Feed Reversing Crank Screw Stud
350583E	18526	Feed Reversing Lever Slide Block Spring Screw
350585C	18523	Feed Driving Connection Hinge Screw
350596X	18524	Arm Section Bolting Screw (long) for 265126
350597X	18524	Arm Section Bolting Screw (short) for 265126

## ACCESSORIES

No.	Plate	Name
265307	18524	Bed Hinge Connection (2)
200570E	18524	Bed Hinge Connection Screw (4)
264645	18503	Bobbin (2)
265130	18522	Bobbin Winder and Bracket Complete
265131	16018	Drip Pan
265136	16018	Feed Reversing Treadle Complete
265084	16149	Foot Lifter and Starting Treadle Complete
41400	13067	Machine Rest Pin
7 x 3	----	Needles, six, size 27
120342	13067	Oiler
228476	13067	Screw Driver (Bobbin Case)
225498	13067	Screw Driver
228776	13537	Thread Unwinder
225554	13067	Wrench

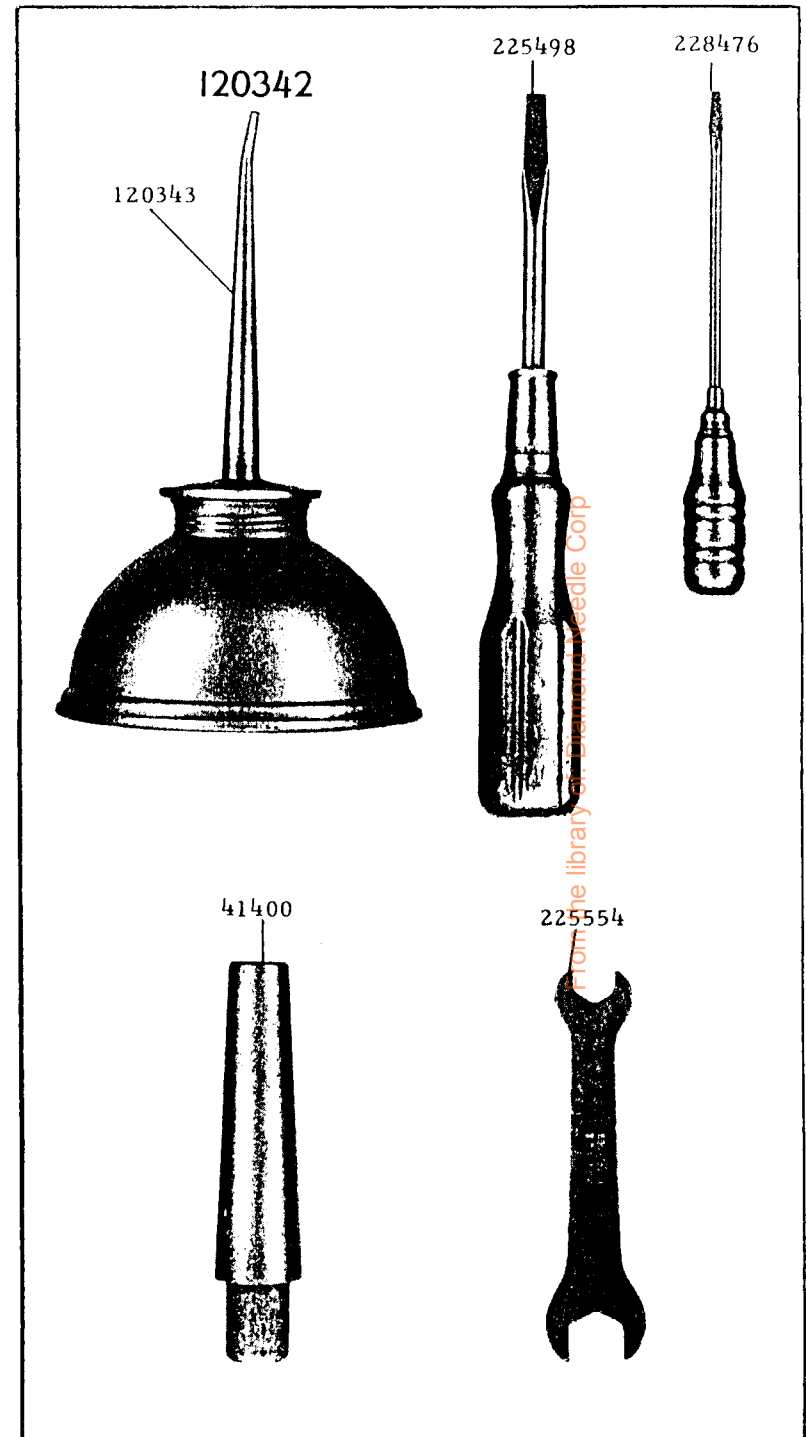

### 228776

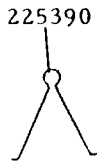
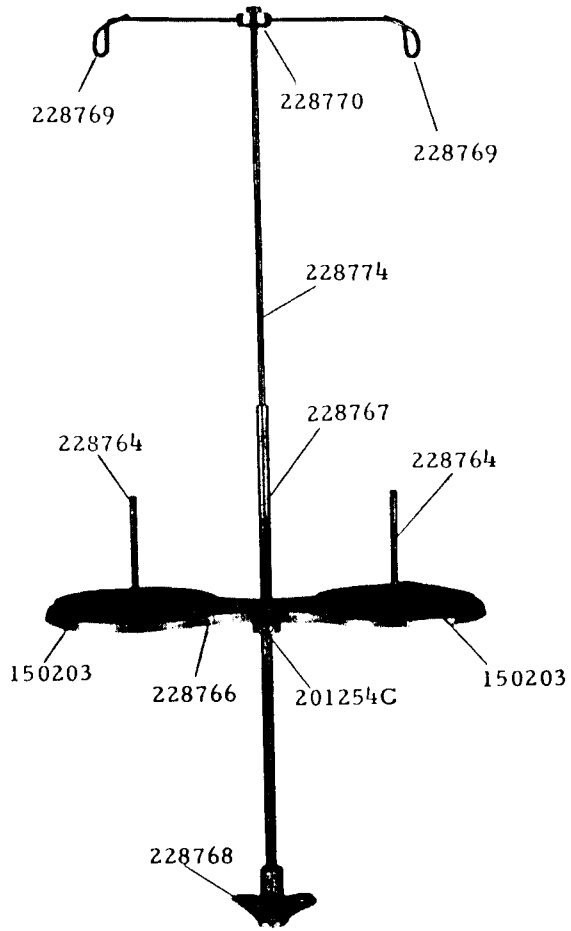

### 265136

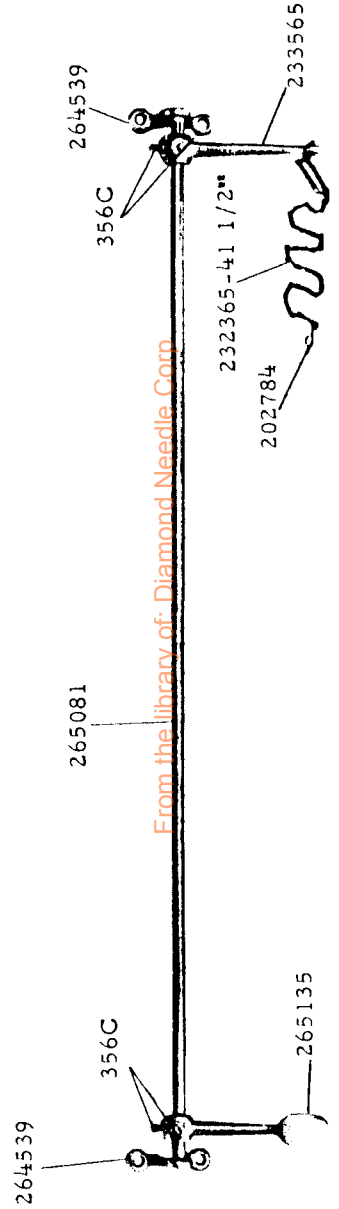

From the library of: Diamond Needle Corp.

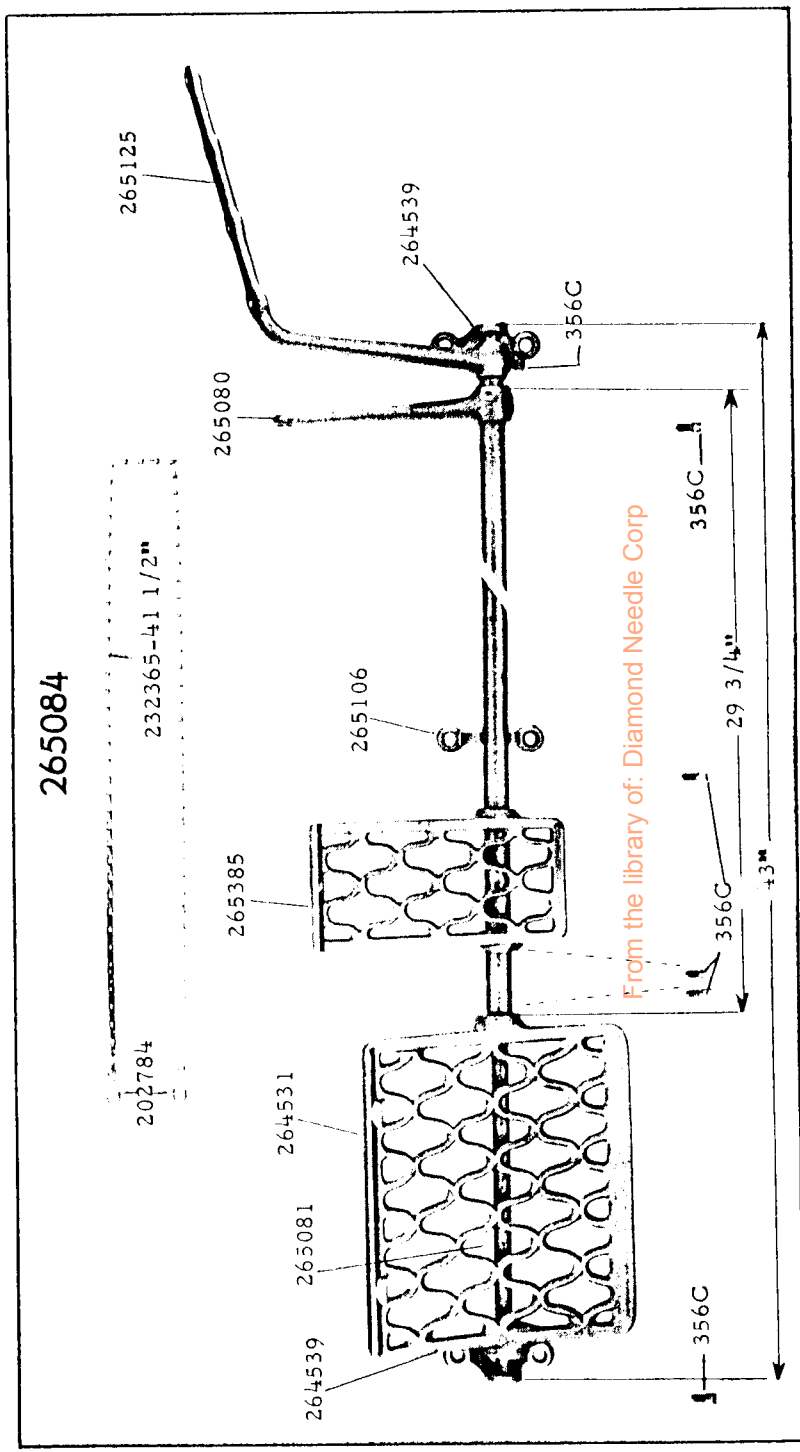
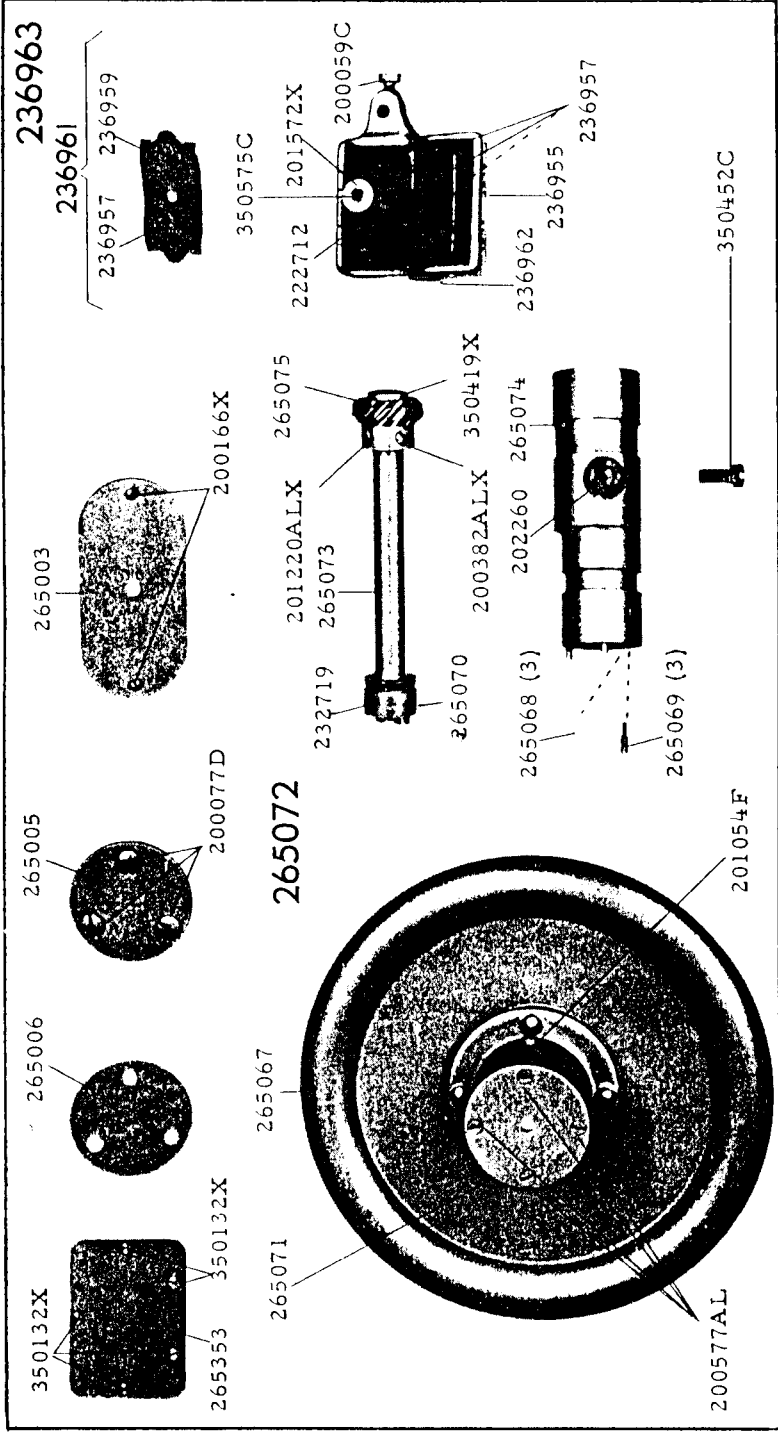

265361

265090

265115

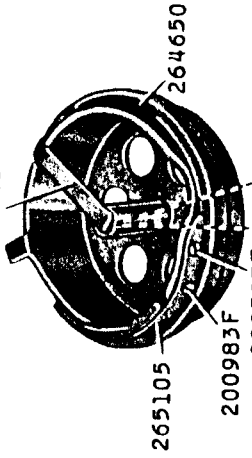

265105

200983F

200597F

264650

264648

264649

\* 265359

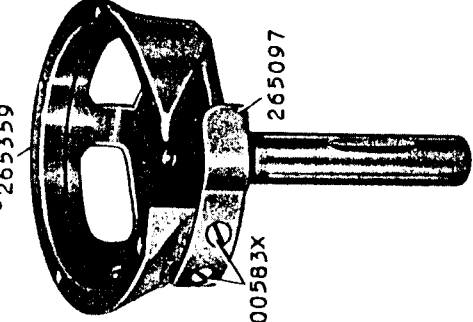

200583X

265097

265360

265096

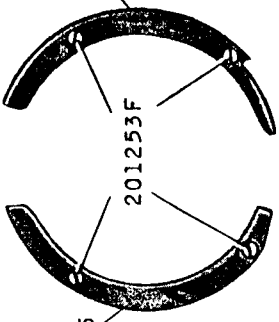

201253F

265095

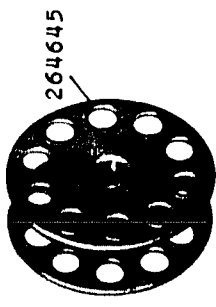

264645

265369

200387C

200403C

265098

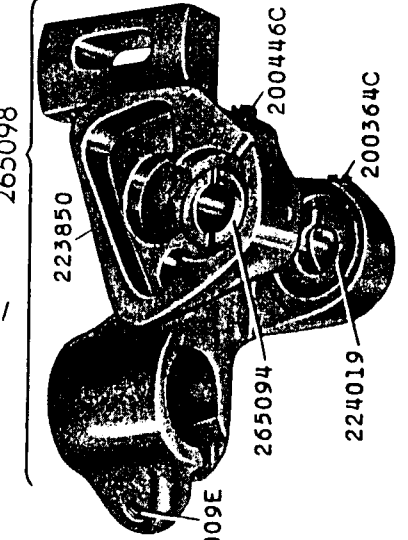

223850

202277

203101

201349C

201542C

265088

265094

224019

200364C

200446C

200009E

265361

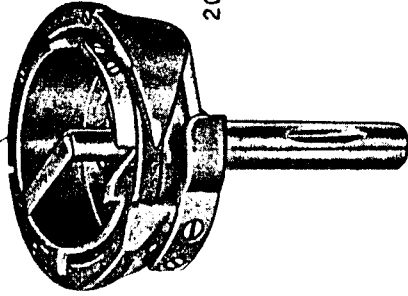

224022



265087

200118D

265066

248251



200006E 225585

From the library of: **Diamond Needle Corp**

240167



200382ALX

201220ALX







### 265046

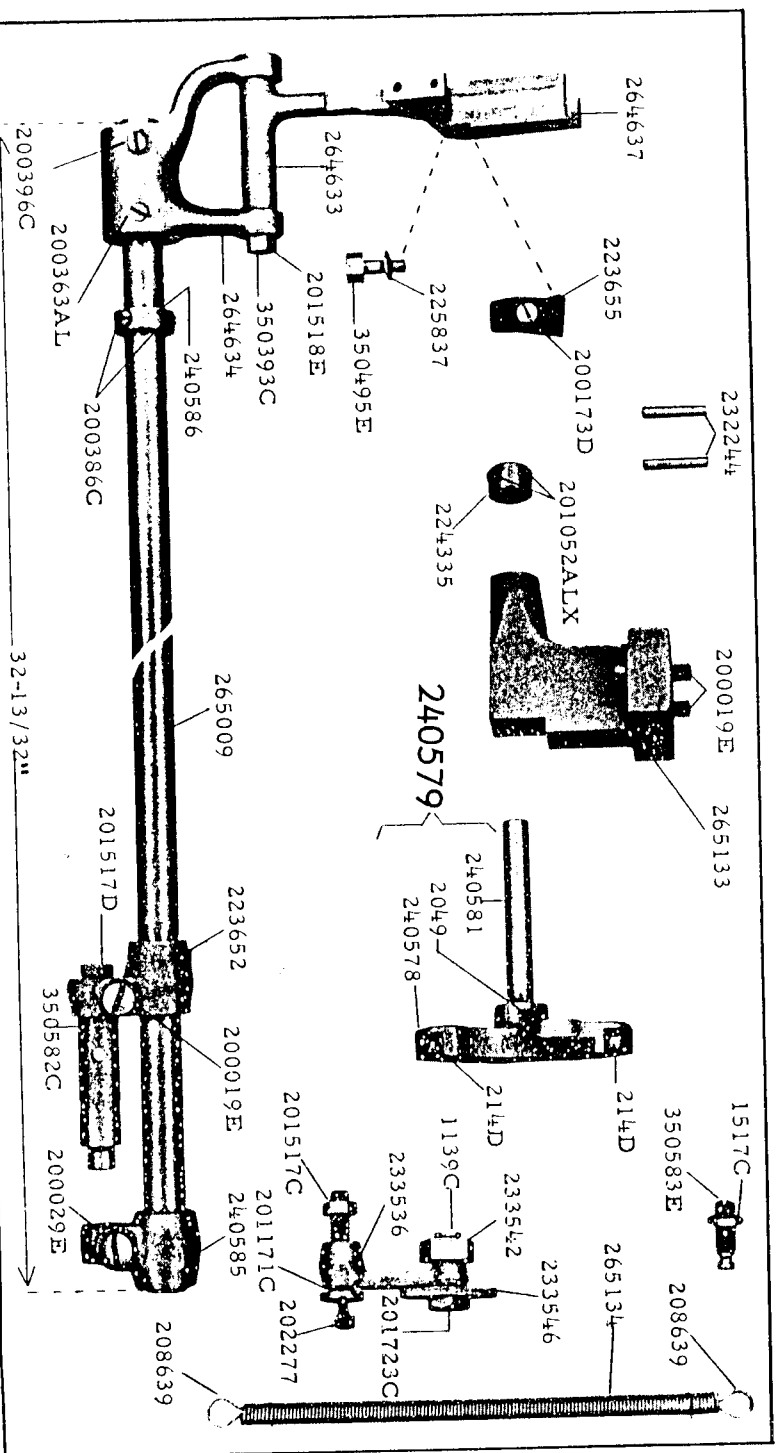
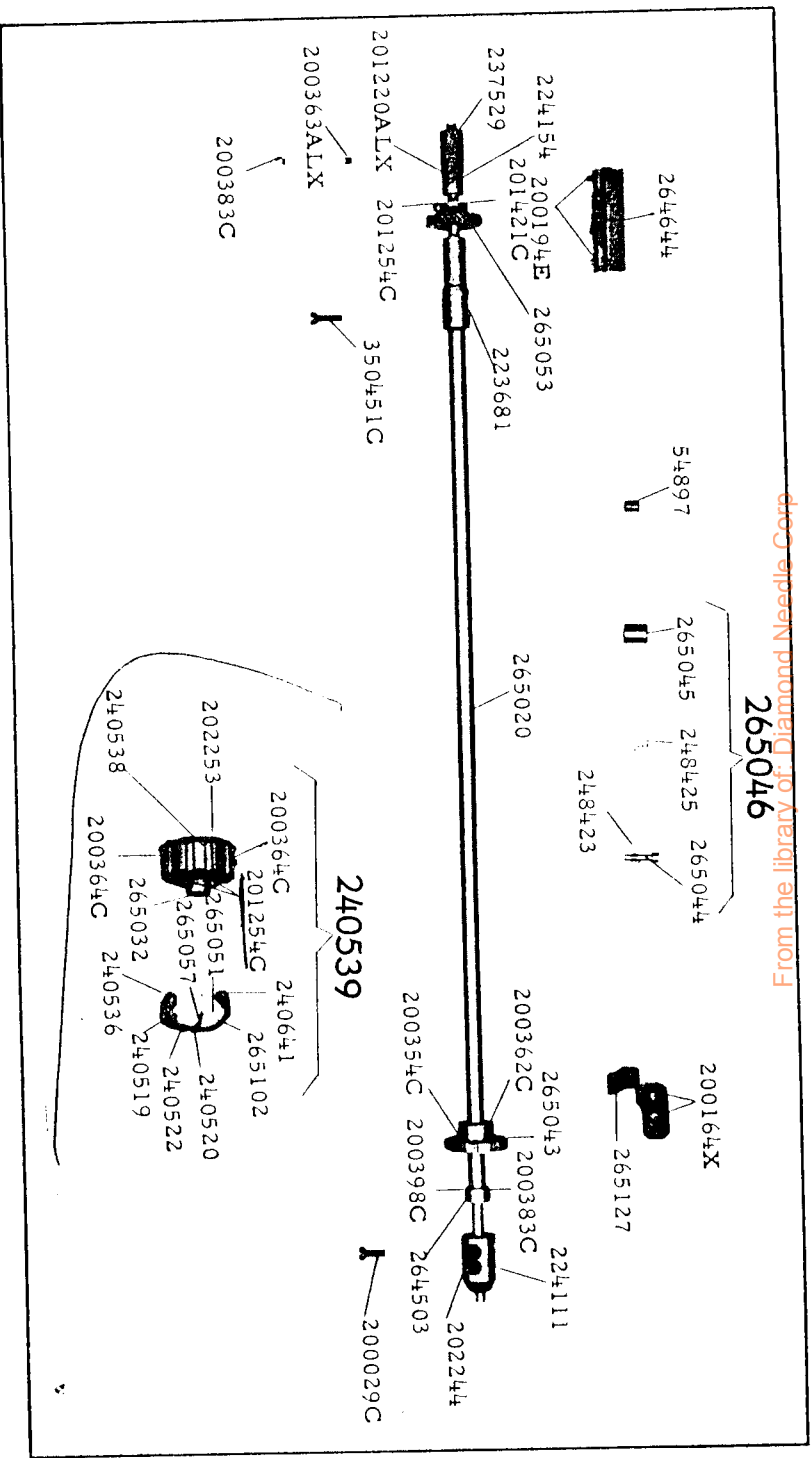

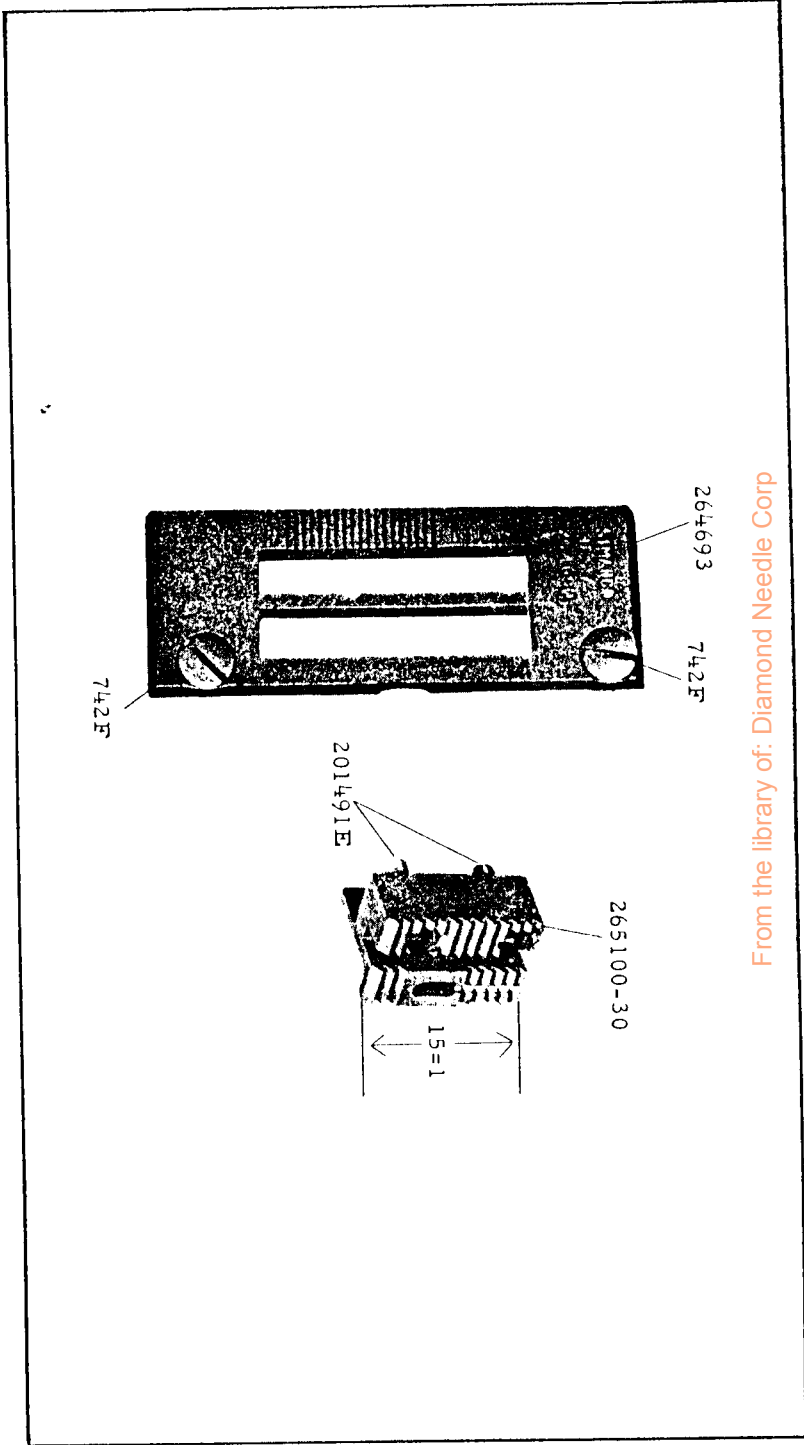
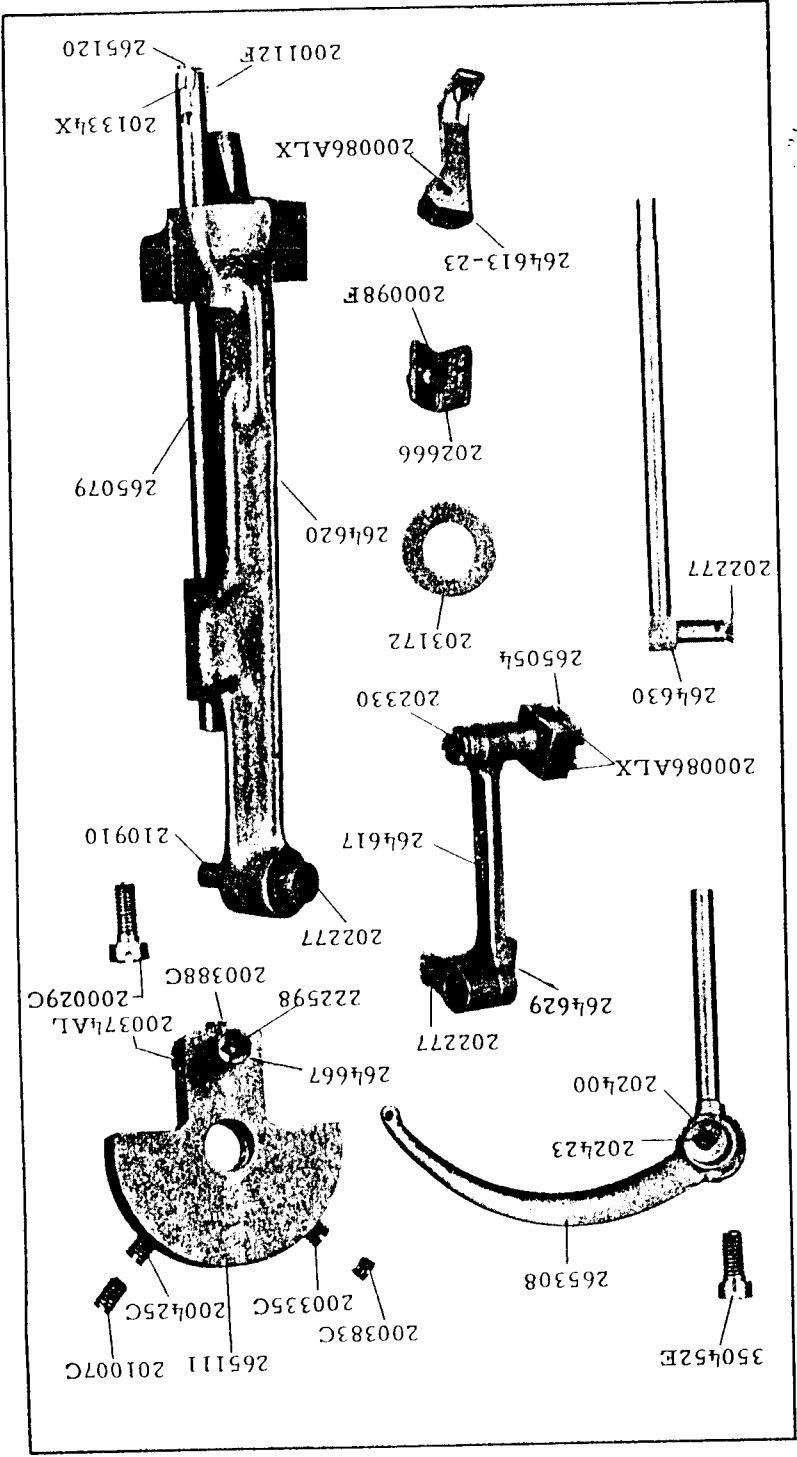

From the library of: Diamond Needle Corp

# 264677

